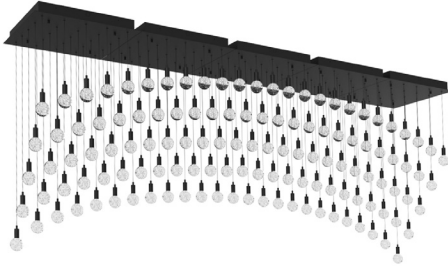

**CAUTION**

Turn off the main power at the circuit breaker before installing the fixture in order to prevent possible shock. If you are unfamiliar with proper electrical wiring connections, obtain the services of a qualified electrician.

**GENERAL**

Read all instructions carefully for safe operation and installation. All electrical connections must be in accordance with local and national electrical code (N.E.C.) standards. Remove the fixture and mounting package from the box. Make sure no parts are missing by referencing the illustrations on these Installation Instructions. Please contact Blackjack Lighting at 847-941-0588 if any parts are missing or damaged. This product is suitable for DAMP locations.

**ASSEMBLY AND INSTALLATION****PREPARATION**

1. Carefully remove the fixture from its box, and carefully unpack the bundled wire packages. Be careful not to bend or kink wires when unpacking. Remove the additional packages with 18 Acrylic Globe pendants (13). Remove the ceiling plate (7) from the canopy cover (8) by loosening the four decorative finials (9).

**MOUNTING**

2. This fixture must be mounted into a rigid ceiling material (sheet rock, fire rated plywood or similar) that can support the weight of the fixture and accept drywall anchors, expandable fasteners or similar structural fasteners (by others).

3. Place the ceiling plate (7) over the junction box. It is recommended to start over a junction box. Drill eight support holes in the ceiling material using an appropriately sized drill bit. Insert ceiling anchors (by others) into the holes. First screw the anchor screws halfway into the ceiling anchors; when the ceiling plate (7) is properly aligned in the installation, fully tighten all anchor screws.

4. Pull the supply wires (2 & 3) and the house ground wire (4) out of the junction box (1) and thread them through the large center hole in ceiling plate (7). If this fixture will be attached to a 0-10V dimmer (optional), also pull the two 0-10V dimming wires through the large center hole.

**INSTALL SPACERS AND JOINERS**

5. For runs that will use fixture spacers (23) and joiner kit(s) (21), first install the female side of the spacers (23) into fixture ceiling plate (7). Thread the male screws (24) through the spacer holes from inside of the ceiling plate (7) housing. Tighten them securely into the spacers (23) to secure. (See Figure 1)

6. Push out large center knock-out (32) from first ceiling plate's (7) mating side. Remove the knurled ring (22) from either side of the joiner (21) and insert one end of threaded tube into the knock-out opening. Re-tighten the knurled ring (22) on one side. (See Figure 1)

a. To mount the second fixture, push out large center knock-out (32) from second ceiling plate. Install the second ceiling plate into the side with the fixture spacers and joiner kit. Insert fixture until it is securely aligned by the threaded rods of fixture spacers. Mark and drill eight support holes using the appropriately

sized drill bit into a rigid ceiling material. Insert ceiling anchors (by others) into the holes. First screw the anchor screws halfway into the ceiling anchors; when properly aligned with the joining ceiling plate (7), fully tighten all anchor screws (16). (see Figure 4) Place knurled ring (22) over the end of the joiner bracket (21), and place the hex nuts (25) over exposed thread on the fixture spacers (23), and tighten. Feed the three conductor 36" extension wire (26) and (Optional) Purple and Grey 36" extension wires (27) through joiner tube (21) into the second fixture. (See Figure 1)

b. For additional connected modules in this first row repeat the procedure above. Note: It is recommended to start with a fixture located at a junction box) and complete a single row. Ensure orientation is correctly squared before proceeding to the next row.

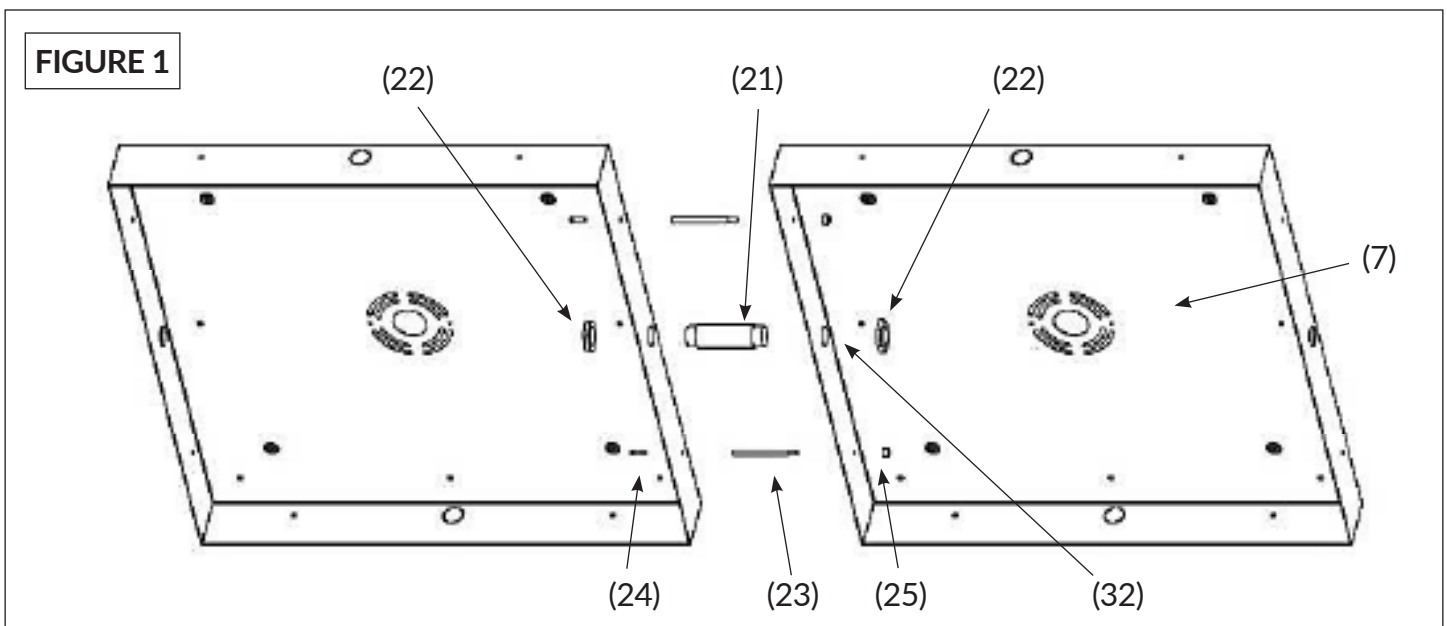

### CONNECT SUPPLY POWER AND DIMMING CABLES TO FIRST OR SINGLE DRIVER

7. Bring the Positive, Negative, and ground leads of the supply wires (2, 3, and 4) to the 3-pole connector (26, 27). Attach these three wires to the male side of the 3-pole connector (27). Connect the Input wires from the driver (17) to one side of the 6 port, female, 3-pole connector (26). (See Figures 2, 3)

a. If connecting to the 0-10v dimming: Bring the dimming control wires (18, 19) to the 2-pole brown connector (33, 34). Attach these two wires to the male side of the brown connector (34). Connect the 0-10v dimming control wires from the driver to side of the 4-port, female, brown connector (33).

b. Connect the male and female 3-pole connectors (26, 27) and the 2-pole brown connectors (33, 34) together when the face plate (8) is suspended below the ceiling plate (7) right before final installation.

**INSTALLATION FOR MULTIPLE INTEGRAL DRIVERS**

**FIGURE 2**

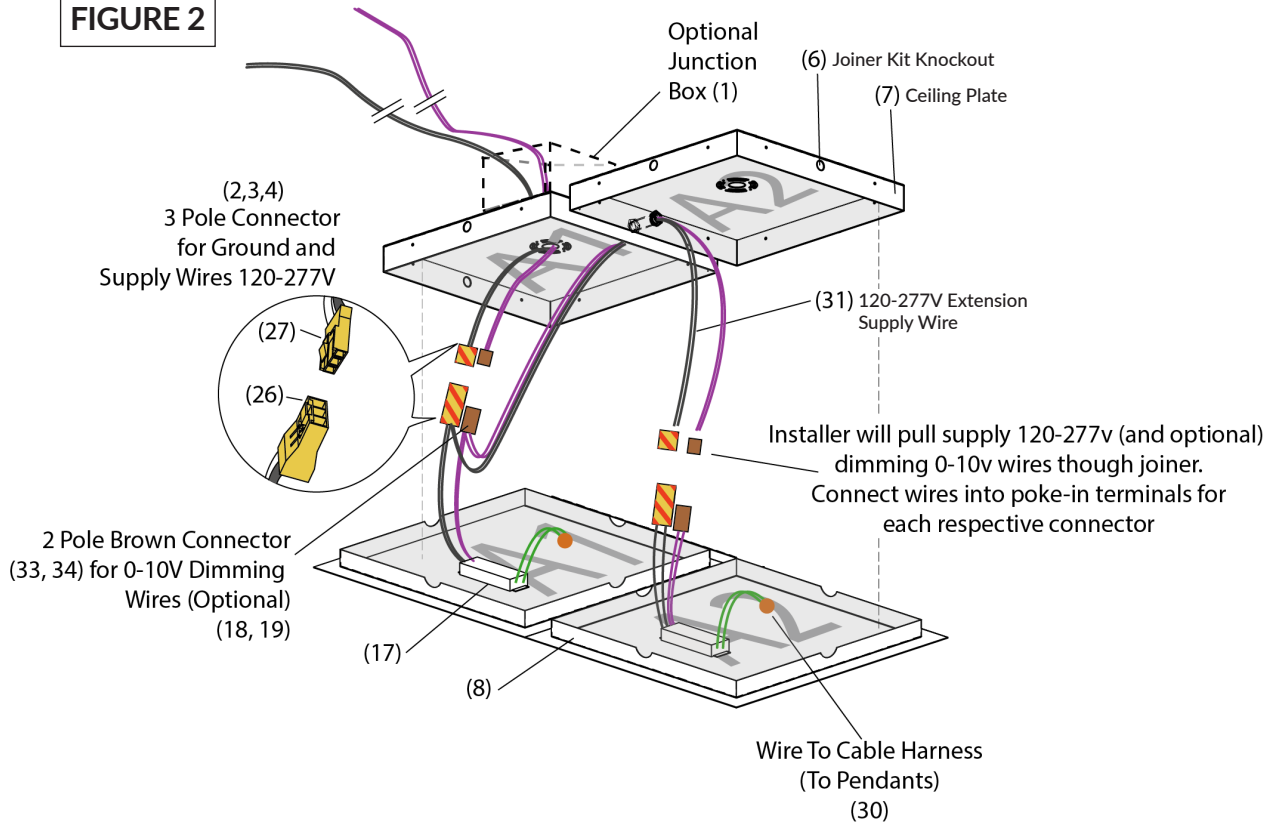

**10.** Bring the Positive and Negative leads from the output wires of the driver (17) to the 3-pole connector (26, 27). (See Figures 2, 3)

- a. Attach these two wires on one side of the 6 port, female, 3-pole connector (26).
- b. Connect the positive and negative output from the extension supply wire (31) to the other side of the 6-port, female, 3-pole connector (26).
- c. Attach the positive and negative output from the other side of the extension supply wire (31) to a male, 3-pole yellow connector (29) after the supply wire (31) is fed through the joiner connecting this canopy to the next one in line to be powered.
- d. If connecting the 0-10v dimming: bring the dimming control wires from the driver to the 2-pole brown connector (33, 34). Attach these two wires to the male side of the brown connector (34). Connect the dimming extension wire (32) to one side of the 4-port, female, brown connector (33).
- e. If connecting the 0-10v dimming: Attach the positive and negative output from the other side of dimming extension wire (32) to a male, brown connector (34) after the dimming extension wire (31) is fed through the joiner connecting this canopy to the next one in line to be dimmed.
- f. Follow the wiring instructions in step #7 for connections to next integral driver.
- g. Connect the male and female 3-pole connectors (26, 27) and the 2-pole brown connectors (33, 34) together when the face Plate (8) is suspended below the ceiling plate (7) right before final installation.

**INSTALLATION FOR MULTIPLE INTEGRAL DRIVERS (Continued)**

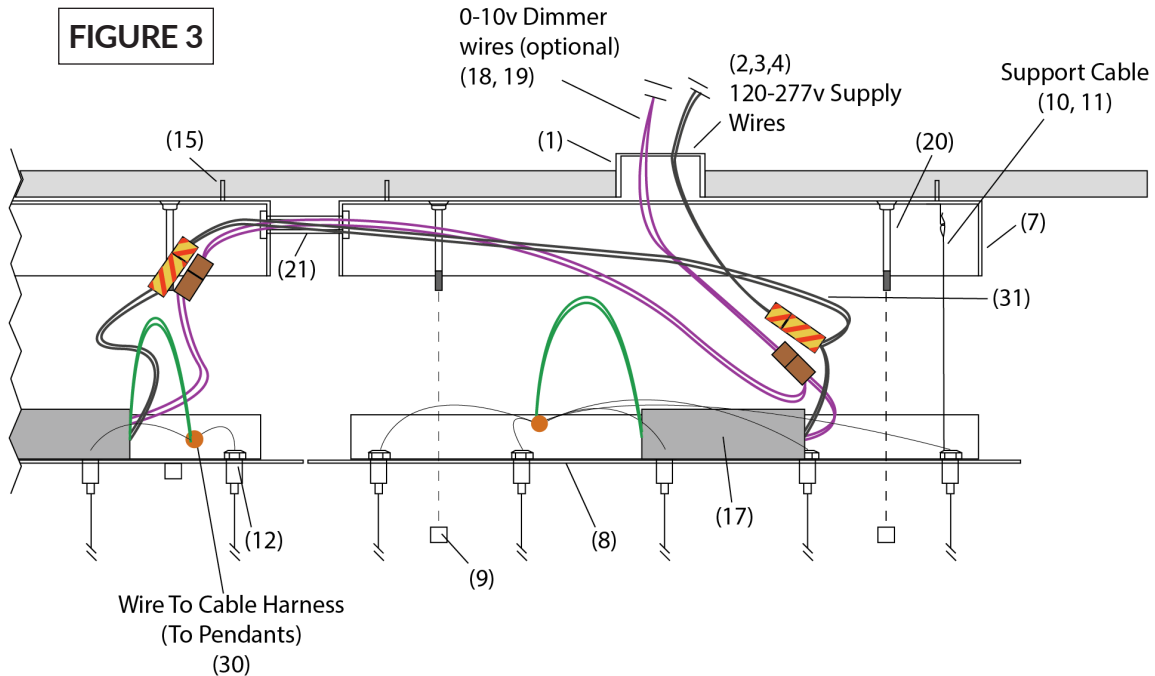

**FINAL ASSEMBLY**

**11.** Assemble Acrylic Globe Pendants (13) and adjust cord lengths before attaching the face plate (8) ceiling plate (7).

**a.** Determine the approximate length of each suspension wire. If in doubt about exact length needed, leave a little extra wire until final installation of face plate (8). Push the excess wire into the canopy by pressing the small barrel of the gripper (12) upward. This will release the wire tension and allow the suspended wire to be pulled through the gripper (12). Roll excess wire into a small loop inside the canopy. Use supplied velcro strap, attached to each wire in the face plate (8).

**12.** Suspend the from face plate (8) from ceiling plate (7) by attaching three support loops (11) to their mating hooks (10).

**13.** Make sure all wires are carefully placed inside face plate (8) and make sure all of the orientation arrows are aligned. Secure the canopy cover (8) to the ceiling plate (7) by aligning the holes in the canopy cover with the threaded standoffs (20), then tighten the four decorative finials (9) onto the threaded standoffs (20). Once the canopy is in place, fine tune the wire lengths longer or shorter to get each light guide adjusted to its preferred length by pushing the end of the gripper (12) (Figure 4).

**Fine Tuning:** Once the length of each wire has been established, any remaining bends or kinks in the wire can be straightened by bending out the kinks by hand while heating the cord with warm air from a hair dryer or heat gun. You may also contact Blackjack Lighting for a handheld wire straightener.

**Dimming:** TRIAC, ELV, or 0-10V dimmable. For recommended dimmers, go to <http://blackjacklighting.com>

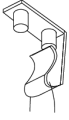

### Hook and Loops (#10, 11)

[ 3 Included ]

### HARDWARE PER FIXTURE



### Decorative Finial (#9)

[ 4 Included ]

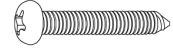

### Anchor Screw (#16)

[ Supplied by others ]

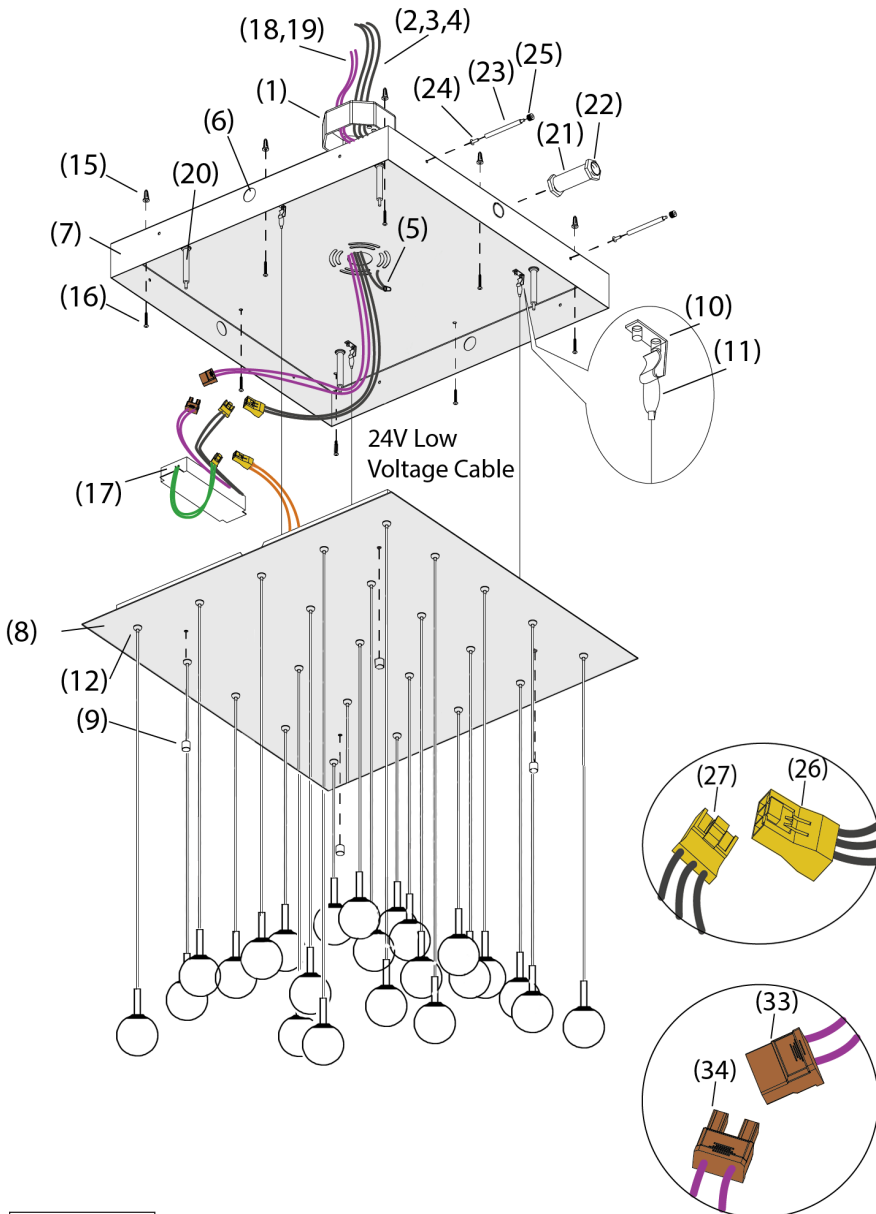

FIGURE 4

1. JUNCTION BOX (By Others)
2. WHITE SUPPLY WIRE
3. BLACK SUPPLY WIRE
4. HOUSE GROUND WIRE
5. FIXTURE GROUND WIRE
6. JOINER KIT KNOCK OUT
7. CEILING PLATE
8. FACE PLATE
9. DECORATIVE FINIAL
10. HOOK
11. LOOP
12. GRIPPER
13. TALL CONE PENDANT
15. CEILING ANCHOR (by others)
16. ANCHOR SCREW
17. DRIVER
18. 0-10V DIMMING + (optional)
19. 0-10V DIMMING - (optional)
20. THREADED STANDOFF
26. 3-POLE 120-277V CONDUCTOR FEMALE
27. 3-POLE 120-277V CONDUCTOR MALE
30. WIRE HARNESS CABLE
31. 120-277 EXTENSION SUPPLY WIRE
32. 0-10V DIMMING EXTENSION WIRE
33. 2-POLE BROWN CONNECTOR FEMALE
34. 2-POLE BROWN CONDUCTOR MALE